









折り図記号解説 - 折り図見方のコツ：折る前に次図をご覧ください



山折り -----	 うしろに折る (山折り)	 おもてに折る (谷折り)	 折り筋を 付け戻す	 横方向に 裏返す	 中を開く	 向き替え	おもて
谷折り -----							うら

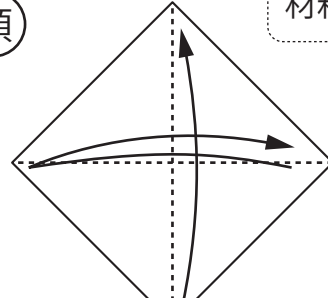
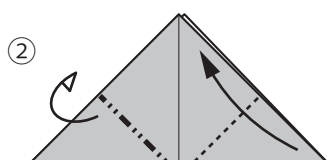
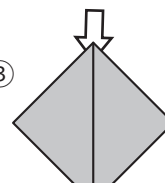

① 頭

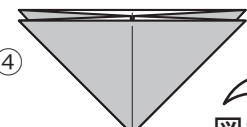

材料 頭：灰15cm-1枚・黒5cm-1枚 体：灰15cm-1枚

①  ②  ③  途中図 

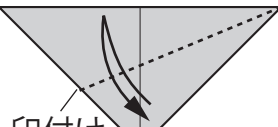

中を広げて三角にする

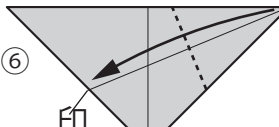
④  図大きく  風船基本形

⑤  印付け  コップ折りのように

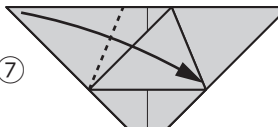
⑥  印 

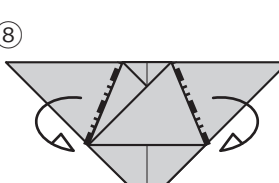
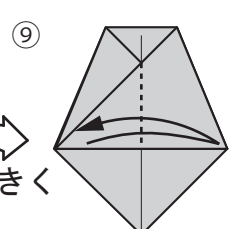

⑦ 

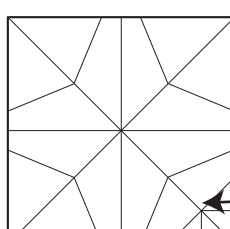
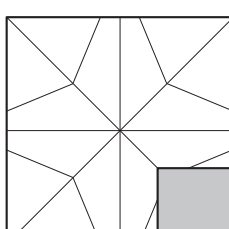
⑧  ⑨  図大きく 

⑩  ⑪ 

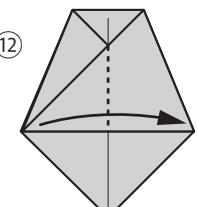
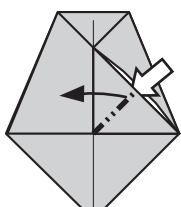
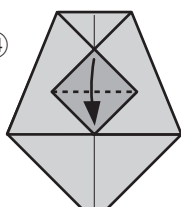
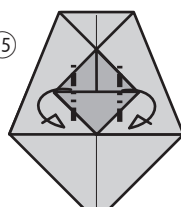
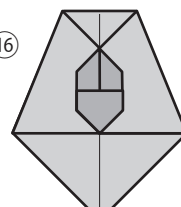
ひろげて折り筋がある方に鼻の紙を貼る ..... ⑨まで戻す

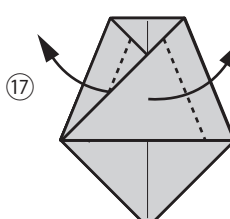
⑫  ⑬  ⑭  ⑮  ⑯ 

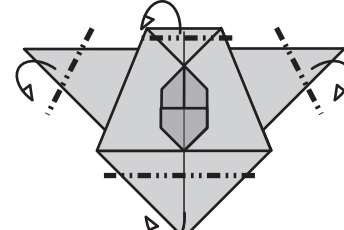
⑰  うらがえす  ⑱ 

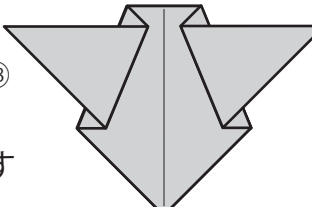
⑱  耳を出す

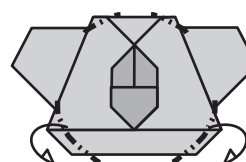
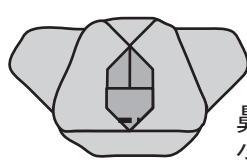
⑳  ㉑  鼻の下を  
少し折る

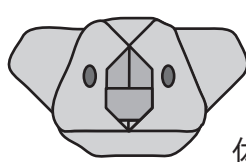
㉒  目を描いて  
できあがり  
体は次ページへ

体

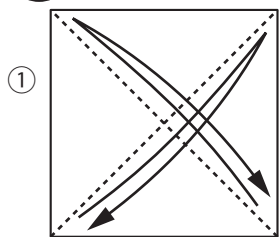

折り筋付け

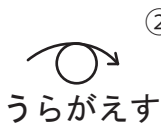

うらがえす

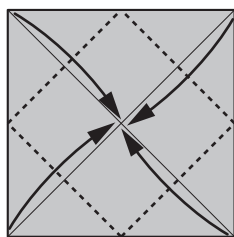

ぎぶとん折り

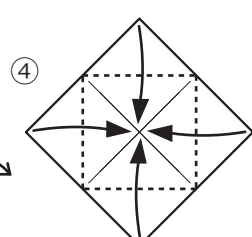
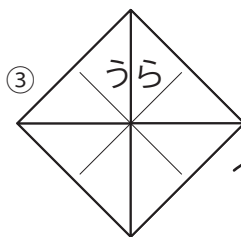

ぎぶとん折り

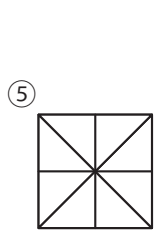

全部開く

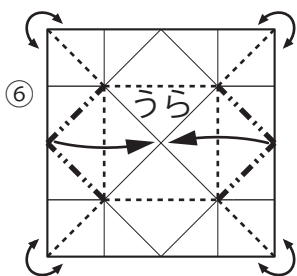

図大きく

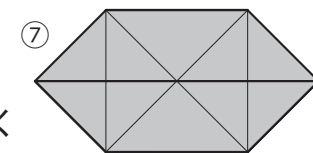

[二そう船の基本形]

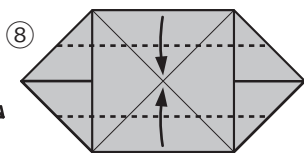

回転するように

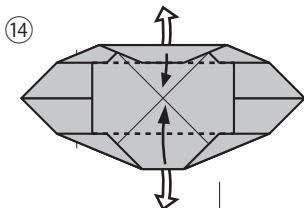
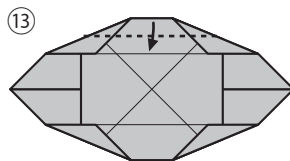
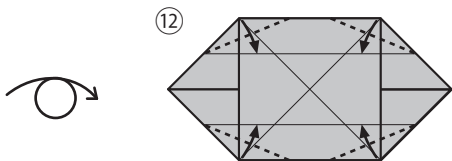
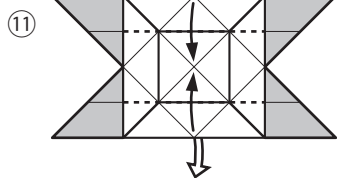
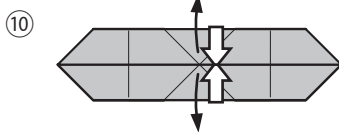
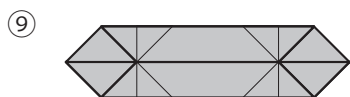

回転するように

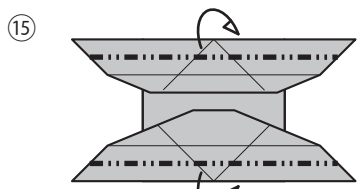

うしろへ

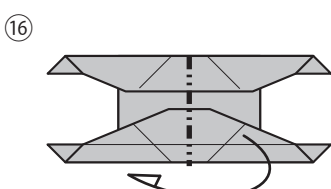

山折り

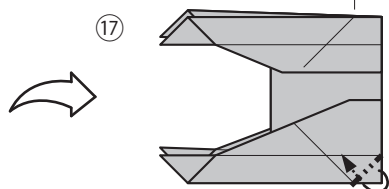

中割り折り

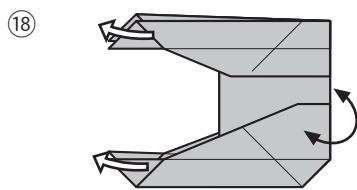

手足を一方に差し込み  
わっかのようにする

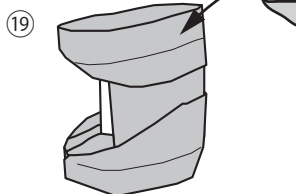

好みの位置に  
のり止め

組み立て

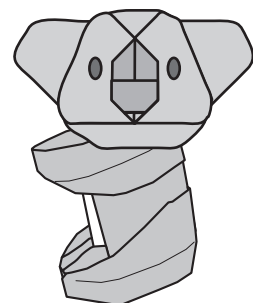

できあがり

指につかまらせたりして遊んでね!